

Blaze TC-6

Twelve channel thermocouple (EGT/CHT) indicator

Operating Manual – English 1.03

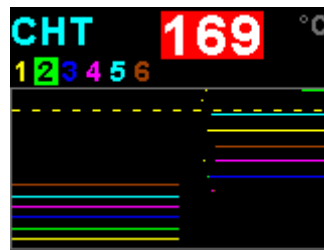
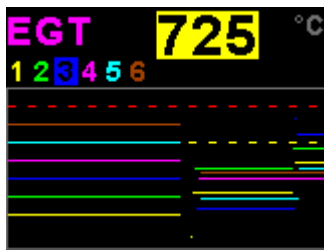
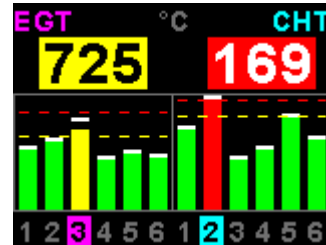

MAX VALUES	
EGT1:	683
EGT2:	809
EGT3:	546
EGT4:	628 °C
RESET	1/3

Introduction

The TC-6 is a 3 1/8" (80mm) sunlight readable 12 channel thermocouple color display instrument that contains all the features necessary to monitor EGT and CHT Thermocouples. The TC-6 can be configured to display up to 12 thermocouples in an easy to read bargraph format.

In addition the TC-6 has an individual programmable EGT and CHT alarm with an external output that can switch an external visual alarm indicator such as a lamp. The TC-6 also has a EGT and CHT trend graph and maximum values display screen. The TC-6's high accuracy is due to its built in thermocouple linearization curves and cold junction compensation techniques. Temperature probes can be common J, K or E type thermocouple probes as used in CHT and EGT senders. Temperatures can be displayed in degrees Celsius or degrees Fahrenheit from -100°C to 1200°C (-148°F to 2192°F).

The TC-6 also features a built in engine leaning facility which allows the pilot to optimize the fuel mixture according to peak EGT temperatures as well as a cruise mode facility to provide instant identification of changing EGT/CHT trends.

The TC-6 can also be interfaced via the CAN bus to an external RDAC unit (Remote Data Acquisition Computer) (Optional). This allows for easier installation as the RDAC unit is normally mounted in the engine compartment.

1 Features

- Large 2.6" high resolution 320x240, IPS (fully viewable in all directions), sunlight readable color LCD display
- 12 Channel thermocouple display unit
- Supports J, K and E type thermocouple probes
- Temperatures can be displayed in °C or °F from -100°C to 1200°C (-148°F to 2192°F)
- High accuracy: Built in thermocouple linearization curves and cold junction compensation
- Records maximum temperatures reached for each channel
- Includes a trend graph display of each thermocouple channel
- Engine leaning function according to peak EGT temperatures
- Engine cruise mode to instantly identify changing EGT/CHT trends
- External RDAC (Remote Data Acquisition Computer) interfacing via the CAN bus (Optional)
- Includes a RS232 serial output for interfacing to external equipment e.g dataloggers etc.
- Standard 3 1/8" (80mm) aircraft enclosure (can be front or rear mounted)
- The LED backlight can automatically adjust to the ambient light, or it can be manually adjusted in the menu system
- Rotary control plus 2 independent buttons for easy menu navigation and user input
- An external output activates when a high alarm condition has been reached
- Wide input supply voltage range of 8 to 30V DC with built in voltage reversal and over voltage protection for harsh electrical environments
- 1 year limited warranty

2 Layout

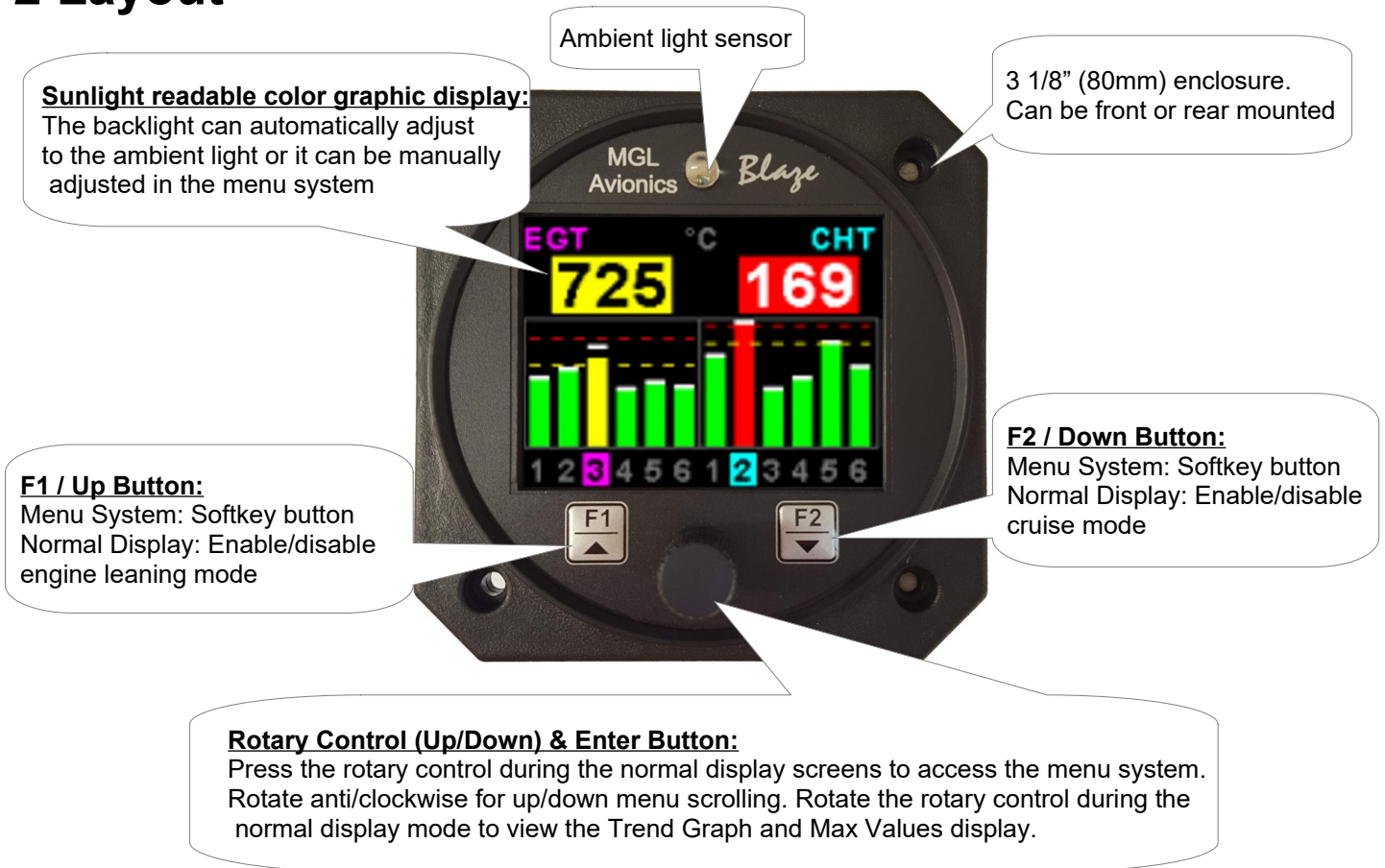

3 Main Displays

The EGT, CHT Trend graph and Max Values displays can be selected by rotating the rotary control.

EGT/CHT Display

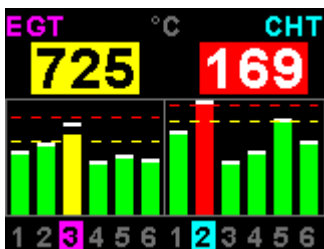

EGT Trend Graph

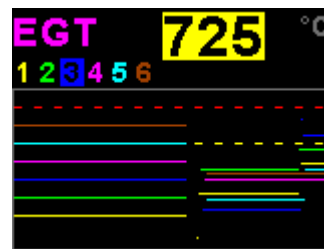

CHT Trend Graph

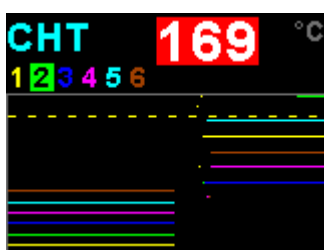

Max Values Display

MAX VALUES	
EGT1:	683
EGT2:	809
EGT3:	546
EGT4:	628 °C
RESET	1/3

3.1 Trend Graph display

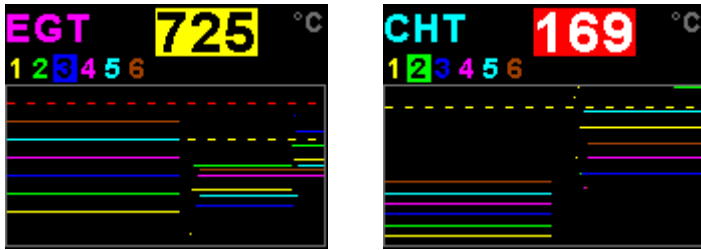

This display can be accessed by rotating the rotary control during the normal display mode. The trend graph displays the last 100 seconds of temperature readings.

3.2 Maximum Values display

MAX VALUES	
EGT1:	683
EGT2:	809
EGT3:	546
EGT4:	628 °C
RESET	1/3

This display can be accessed by rotating the rotary control during the normal display mode. Press the F1/Up button when the max values display is showing to reset the maximum values to the current temperature values.

Note: The maximum values are stored in non-volatile memory and are recalled on power-up.

3.3 Engine leaning mode

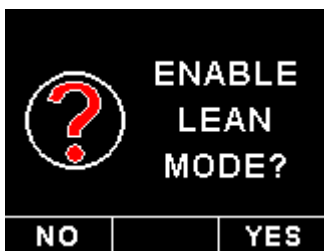

EGT information is also very useful for fuel mixture control. As the fuel mixture is leaned, so the exhaust gasses get hotter. This rise in temperature is a sign of increased combustion efficiency as the optimum mixture setting is approached. If the leaning progresses past a certain point however, the temperature will begin to drop. This temperature drop is the result of reduced energy output from the diminished fuel flow. The best operating mixture for aircraft engines is in the vicinity of this peak EGT reading. The TC-6 has a special Leaning mode, which easily identifies the peak EGT condition allowing you to adjust your fuel mixture for best performance.

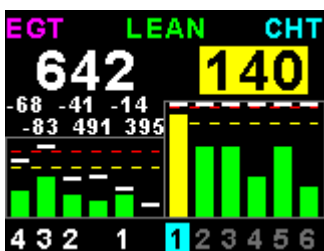

Fuel mixture should be adjusted once you have decided on a suitable cruise power setting (typically 70%). Press the F1/Up button on the main display to enable the engine leaning mode. The "LEAN" label is displayed at the top of the main display to clearly differentiate it from the normal operating mode.

As the fuel mixture is slowly leaned past the point at which the temperature begins to drop (by more than 10°C/15°F), the absolute EGT temperatures will change to show the EGT reading relative to this peak. The sequential order as each cylinder peaks is also shown.

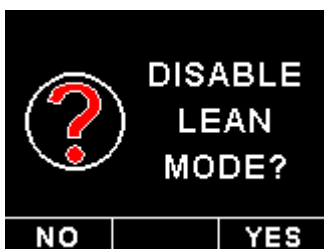

Leaning mode can be canceled by pressing the F1/Up button again.

3.4 Engine cruise mode



Once in the cruise, press the F2/Down button to enable the Cruise Mode. The "CRUISE" label is displayed at the top of the main display to clearly differentiate it from the normal operating mode. All EGT and CHT readings are immediately sampled as reference temperatures for the cruise.

The display then shows EGT and CHT values relative to this reference temperature.

Cruise mode can be canceled by pressing the F2/Down button again.

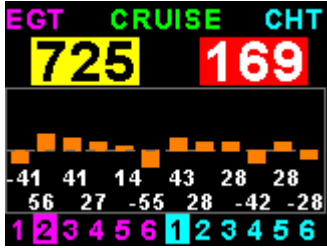

4 Menu System

Press the rotary control button during the normal display mode to enter the menu system. Use the rotary control to navigate through the menu system.

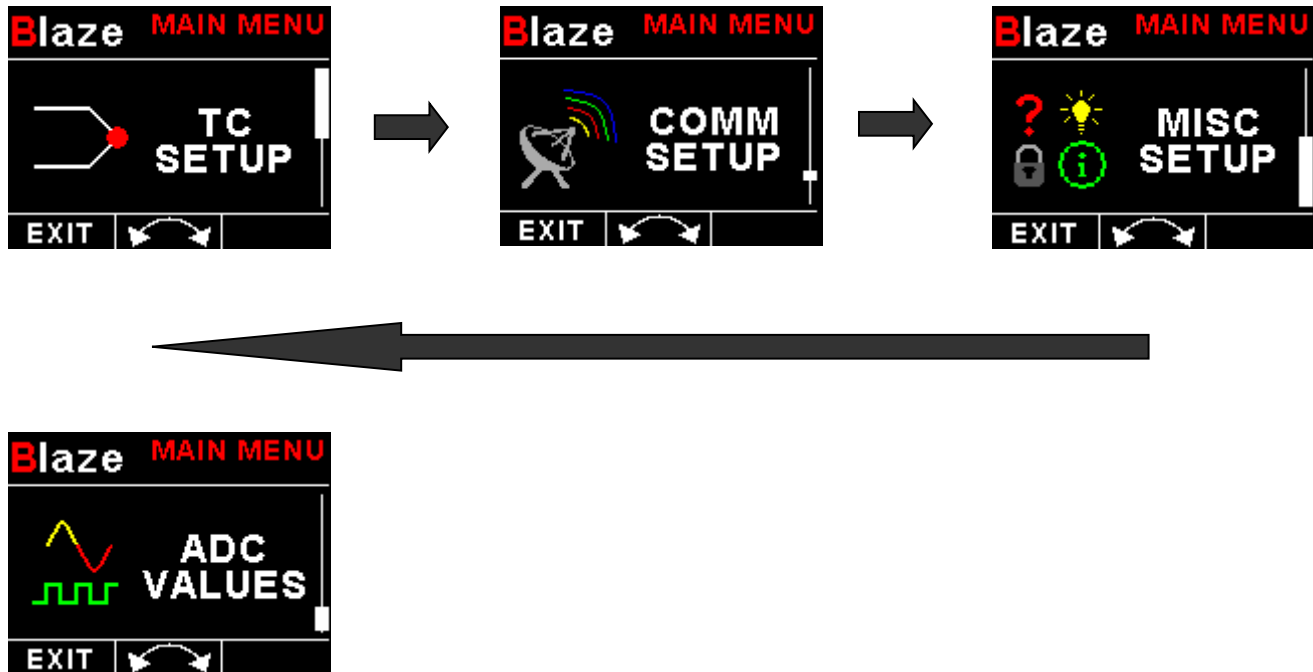

4.1 Exiting the menu system

Press the F1/Up button to exit the menu system when the "EXIT" soft key is shown. All changes made during navigation of the menu system will be saved in non-volatile memory upon exiting. The instrument will not save any changes if you remove power before exiting the menu system.

4.2 TC Setup (Thermocouple Setup)

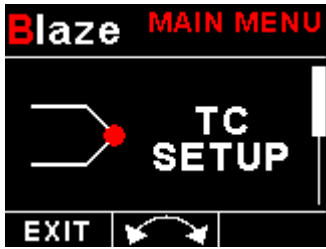

4.2.1 EGT/CHT TC Setup menu options

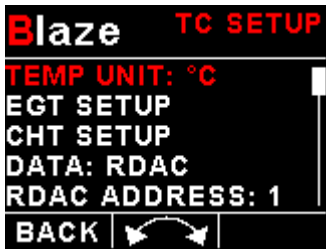

Temp Unit:

Select whether you want the temperature to be displayed in degrees Celsius (°C) or degrees Fahrenheit (°F).

EGT Setup

Select this menu option to setup the EGT thermocouples. See EGT/CHT Setup menu option below.

CHT Setup

Select this menu option to setup the CHT thermocouples. See EGT/CHT Setup menu option below.

Data:

Select the data source of the thermocouples. Options include internal (using the internal thermocouple amplifier and Blaze connector) or from an optional external RDAC unit.

RDAC Address:

Select the CAN address of the external RDAC unit.

EGT/CHT Setup menu option



EGT / CHT Channels:

Select the number of EGT or CHT channels you want to use. Choices are from 1 to 12. The temperature display will configure itself to make best possible use of the available display size. Please note that the minimum number of EGT & CHT channels that can be displayed is 1 and the maximum number of EGT and CHT channels that can be displayed is 12.

Display:

A selection between "HIGHEST" or "SCANNING" can be selected. If "HIGHEST" is selected then the current highest thermocouple temperature is displayed. If "SCANNING" is selected then the unit will cycle through each thermocouple at a one second interval.

Display Max:

Select the maximum temperature that you want the EGT/CHT bargraph to show. This can give you increased display resolution.

Display Min:

Select the minimum temperature that you want the EGT/CHT bargraph to show. This can give you increased display resolution.

High Alarm:

This enables or disables the EGT/CHT high alarm.

High Alarm:

Enter the temperature threshold for when the high alarm must be activated. Any temperature above this value will activate the alarm.

High Caution:

Enter the temperature value for the high caution.

Probe:

Select if you are using a K-type, J-type or E-type thermocouple probe for this channel. All probes supplied by MGL Avionics are K-Type. J-types are sometimes used with American made CHT probes. All EGT probes are K-type. E-type probes are seldom used.

4.3 COMM Setup (Communication Setup)



Serial Out:

Select "ON" to enable the RS232 serial output.

Unit Address:

Enter the unit address.

Baud Rate:

Select the desired baud rate of the serial output.

The transmission format is set to 8 data bits, No parity, 1 stop bit. The baud rate can be changed in the Communication Menu.

4.3.1 Protocol Format

STX, Address, Message type, Length, Data payload, Checksum, ETX

STX: Start of text (0x02)

Address: unsigned char (8bit), Unit address (range 0-255)

Message Type: unsigned char (8bit), Specifies the message type

Length: unsigned char (8bit), Length of the data payload (does not include the STX, Address, message type, checksum or ETX)

Data payload: Data

Checksum: unsigned char (8bit), XOR of all bytes starting from the unit address to the end of the data payload. The checksum is seeded with 0xa5. (does not include the STX or ETX)

ETX: End of text (0x03)

4.3.2 Data payload

Message type=4

Data Length=26 bytes

Output Rate=1Hz

Unused channels will read 0

CJC: Signed Int (16 bit), Cold junction temperature in Degrees Celsius

TC1: Signed Int (16 bit), Thermocouple channel 1 in Degrees Celsius

TC2: Signed Int (16 bit), Thermocouple channel 2 in Degrees Celsius

TC3: Signed Int (16 bit), Thermocouple channel 3 in Degrees Celsius

TC4: Signed Int (16 bit), Thermocouple channel 4 in Degrees Celsius

TC5: Signed Int (16 bit), Thermocouple channel 5 in Degrees Celsius

TC6: Signed Int (16 bit), Thermocouple channel 6 in Degrees Celsius

TC7: Signed Int (16 bit), Thermocouple channel 7 in Degrees Celsius

TC8: Signed Int (16 bit), Thermocouple channel 8 in Degrees Celsius

TC9: Signed Int (16 bit), Thermocouple channel 9 in Degrees Celsius

TC10: Signed Int (16 bit), Thermocouple channel 10 in Degrees Celsius

TC11: Signed Int (16 bit), Thermocouple channel 11 in Degrees Celsius

TC12: Signed Int (16 bit), Thermocouple channel 12 in Degrees Celsius

4.4 MISC Setup (Miscellaneous Setup)



Backlight:



Select manual or automatic backlight control.

Use the rotary control in manual mode to adjust the backlight brightness.



Allow 3 seconds for the display to adjust to the ambient lighting conditions when using the automatic backlight mode. The display will set the backlight to the dim setting if the ambient light is less than the threshold setting, alternatively the display will set the backlight to the bright setting if the ambient light is greater than the threshold setting. The ambient light received is shown as the ADC value in the top header. Use this value to set the threshold value.

Security Setup:



Select this menu option if you want to password protect the menu system.



Information:

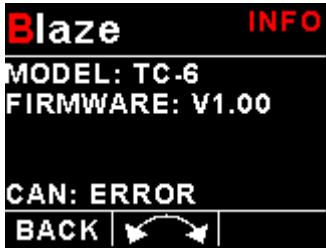

This menu option displays information about the unit.

Default Settings:

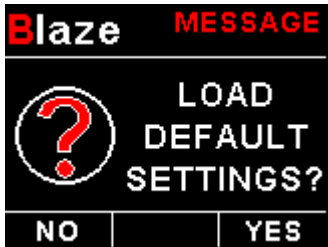

Select this menu option to reset all the settings to factory defaults.

5 Loading factory default settings



Press and hold the F1/Up button and rotary control during power up to load the pre-programmed factory default settings. The following screen will be displayed:

Factory default settings can also be loaded in the Miscellaneous setup menu.

6 Error Messages



UNIT
SETTINGS
CRC ERROR

Unit settings CRC error. Load default settings to restore to factory defaults. If the error message still persists then it could possibly be a non-volatile memory failure in which case the instrument will then have to be returned to the factory.



INTERNAL
FLASH
CRC ERROR
UNIT:123456
CODE:654321

Internal flash CRC error. The instrument does a firmware check on the program when power is applied to the instrument. If the program is corrupt in any way then the internal flash CRC error will be displayed. Reload the instruments firmware and load default settings. If the error message still persists then it could possibly be an internal flash memory failure in which case the instrument will then have to be returned to the factory.



CALIBRATION
CONSTANTS
CRC ERROR

Calibration constants CRC error. The instrument could possibly have a non-volatile memory failure in which case the instrument will then have to be returned to the factory.



MAX VALUES
CRC ERROR

Max Values CRC error. Load default settings to restore to factory defaults. If the error message still persists then it could possibly be a non-volatile memory failure in which case the instrument will then have to be returned to the factory.

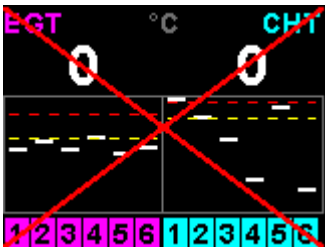

The red cross over the display means the TC-6 has lost communications with the external RDAC unit. Check the wiring between the TC-6 instrument and the RDAC unit. This error message is only available when the external RDAC is selected as the thermocouple data source.

7 Specifications

Operating Temperature Range	-10°C to 60°C (14°F to 140°F)
Storage Temperature Range	-20°C to 80°C (-4°F to 176°F)
Humidity	<85% non-condensing
Power Supply	8 to 30Vdc SMPS (switch mode power supply) with built in 33V over voltage and reverse voltage protection
Current Consumption	Approx. 145mA @ 12V (backlight highest setting), 65mA @13.8V (backlight lowest setting)
Display	2.6" 320x240 IPS color LCD display Minimum 600cd/m2 brightness Sunlight readable with anti-glare coating LED Backlight can be set to automatic or can be manually adjusted
Alarm Output	Open collector transistor switch to ground Maximum rating 0.25A
ADC	12 bit
Dimensions	see Blaze series dimensional drawing
Enclosure	3 1/8" (80mm) ABS, black in color, front or rear mounting. Flame retardant.
Weight	Approx. 180 grams (Instrument excluding cables)
Non-volatile memory storage	100000 write cycles
Thermocouples	J-type, K-type and E-Type
Measurement range	TC-6 Internal amplifier K-Type: -100°C to 1200°C (-148°F to 2192°F) J-Type: -100°C to 1100°C (-148°F to 2012°F) E-Type: -100°C to 800°C (-148°F to 1472°F)
Technology	Fully cold junction compensated using a precision internal temperature reference and built in thermocouple linearization tables
Measurement accuracy	+/- 5 degrees typical over full temperature range, subject to quality of probe used. We recommend MGL Avionics EGT and CHT probes
Inputs	Differential, can use grounded and isolated probes
Common mode voltage range	-2V to +3V

8 Operating the alarms

The alarm output can be used to switch an external alarm indicator. The external alarm switch is an open collector transistor switch to ground with a maximum rating of 0.25A DC. It is possible to wire the alarm contacts of several Stratomaster instruments in parallel should this be desired. To avoid false activation of the alarms, the alarm function is only active 10 seconds after the instrument has powered up.

9 Firmware Upgrading

The TC-6 can be upgraded in the field by connecting the RS232 port to a PC and running the firmware update program. **Note that only the RS232 port can be used to upgrade the firmware.**

Please see the Blaze firmware upgrading document for more information.

10 Installation

The TC-6 provides for up to 12 thermocouple inputs for use with EGT and CHT probes. K, J as well as E-type probes can be used. K types are used for EGT probes while CHT probes can either be J or K type. E-type probes are seldom used. Probe types are selected in the various "TC SETUP" menus of the TC-6.

Important: Incorrect selection of probe type will lead to an incorrect temperature display.

The TC-6 will accept both grounded and isolated thermocouple probes. Your only consideration in case of the more common grounded configurations is that you need to ensure that the thermocouple mounting position (exhaust flange, etc.) is at the same electrical potential as the negative supply line of the TC-6.

The thermocouple amplifier is a precision device providing full cold junction compensation. This results in very accurate measurements providing you install high quality probes. Here are some guidelines:

EGT Probes: Select probes that are made from 316 stainless steel and that use glass-fiber insulated conductors. Teflon insulated conductors as found in many cheap probes introduce errors as the insulation melts moving the measuring point towards the mounting bolt which transfers a lot of heat to the exhaust material. This results in under reading probes. Stay away from probes that use simple plastic heat shrink sleeving – it does not last. Choose probes that use a generous amount of stainless steel spring as strain relief. The bolt itself should be stainless steel as well or it will rust very quickly.

CHT Probes: These are made from washers to fit spark-plug bases. Temperatures are considerably lower so most thermocouple cables will work without problems. The biggest area of concern should be the connection of the thermocouple cable to the washer. This often breaks after the spark plug has been changed a few times. Choose a probe that is suitably reinforced at this point for a long and trouble free life.

EGT and CHT probes supplied by MGL Avionics are of the highest quality. We recommend that you consider using our probes if at all possible.

EGT and CHT probes use wire made from iron and other basic metals. As a result these probes are not able to withstand much flexing of the wires due to engine vibrations. Avoid making nice looking coils or similar constructions that will result in excessive vibration or flexing of the wire. Route the cables from the probe points tightly along suitable engine mounting points eliminating any chance of unnecessary wire flexing during engine operation.

Warning: Four stroke engines produce much hotter exhaust gases compared to two stroke engines. Do not use EGT probes made from lower grade stainless steel (for example 310), these probes will not withstand the high temperatures and can fail as the metal gets very soft at 800 degrees C. Many four strokes (such as the Rotax 912) will produce exhaust gases of up to 850 degrees C.

Extending the leads of thermocouple probes:

Thermocouple leads as used with the EGT and CHT probes can be extended either with ordinary copper cable or with special K-Type extension cable. The choice of either depends on your desired accuracy. If it is possible in your installation to ensure that both ends of a copper extension cable will be at the same temperature (or very close), then it is quite possible to use the copper cable. In most open-air installations this will be the case. Should this not be possible or you require best possible accuracy at all times, you can obtain a special K-type extension cable. This cable is made from the same metals as your probes cable and uses ordinary plastic sleeving as insulation. In either case, ensure that the cable is not routed close to sources of electromagnetic interference of any kind. The voltages present in this cable are very small and are subject to changes applied by external fields. This can lead to false temperature indications. You can check your installation by using a hand-held transmitter, such as an air band radio. If you transmit a signal, no change in temperature reading should occur.

Notes on thermocouple connections:

For maximum accuracy of the thermocouple temperature measurement, please ensure that either end of the harness cable (where used for thermocouple probes) is at fairly even temperature (minimise the temperature difference between the connector side of the cable and the side where you connect the thermocouple). If required, shorten the cable to fulfil this need.

The following rules apply regarding the order in which EGT and CHT probes are connected:

Rule 1: EGTs go first (all in a row)

Rule 2: CHTs go next (all in a row)

Rule 3: No gaps. Don't leave spaces between EGTs and CHTs when connecting to device.

Examples:

If you have 1 EGT and 1 CHT:

TC Channel 1: EGT

TC Channel 2: CHT

If you have 2 EGTs and 2 CHTs:

TC Channel 1: EGT

TC Channel 2: EGT

TC Channel 3: CHT

TC Channel 4: CHT

If you have 1 EGTs and 4 CHTs:

TC Channel 1: EGT

TC Channel 2: CHT

TC Channel 3: CHT

TC Channel 4: CHT

TC Channel 5: CHT

Etc...

Note: Connect the TC-6 ground to the engine block, and the engine block to battery negative. Do not connect the TC-6 ground directly to the battery negative. This must be routed via the engine block.

Note: Always install EGT probes starting on Channel 1 followed by the CHT probes without skipping any channels in between.

External RDAC (Remote Data Acquisition) Connection (Optional)

The TC-6 can use an external RDAC unit as the source for the thermocouples. Using an external RDAC may be beneficial as it will reduce the wiring from the engine compartment to the cockpit. Only the CAN High and CAN Low connections need to be made between the RDAC unit and the TC-6 in order for this to work. Select "RDAC" for the data source in the TC Setup menu if using the external RDAC option. The RDAC unit is optional and is purchased separately.

10.1 Cable connections

Main connector (D15HD connector: Unit Female, Cable Male)

D15 Pin	Color	Function
1	Red	8-30Vdc power via power switch / circuit breaker and fuse.
2	Black	Ground. Connect the ground to the engine block, and the engine block to the battery negative. Do not connect the TC-6 ground directly to the battery negative. This must be routed via the engine block.
3	-	RS232 Transmit data (Firmware upgrading)
4	-	RS232 Receive data (Firmware upgrading)
12	Purple	CAN Low (Used for optional external RDAC)
13	Pink	CAN High (Used for optional external RDAC)
15	White	Alarm Output (Open collector)

Thermocouple (EGT/CHT) connector (D25 connector: Unit Female, Cable Male)

In case of MGL Avionics K-Type probes + = Yellow probe lead, - = Red probe lead

D25 Male Pin	Function
1	TC Channel 1 +
14	TC Channel 1 -
2	TC Channel 2 +
15	TC Channel 2 -
3	TC Channel 3 +
16	TC Channel 3 -
4	TC Channel 4 +
17	TC Channel 4 -
5	TC Channel 5 +
18	TC Channel 5 -
6	TC Channel 6 +
19	TC Channel 6 -
7	TC Channel 7 +
20	TC Channel 7 -
8	TC Channel 8 +
21	TC Channel 8 -
9	TC Channel 9 +
22	TC Channel 9 -
10	TC Channel 10 +
23	TC Channel 10 -
11	TC Channel 11 +
24	TC Channel 11 -
12	TC Channel 12 +
25	TC Channel 12 -

10.2 Connection Diagram

The use of an external 1A fuse is recommended. Connect the supply terminals to your aircrafts power supply. The TC-6 can be used on both 12V and 24V without the use of any pre-regulators. Ensure that the supply voltage will not drop below 8V during operation as this may result in incorrect readings.

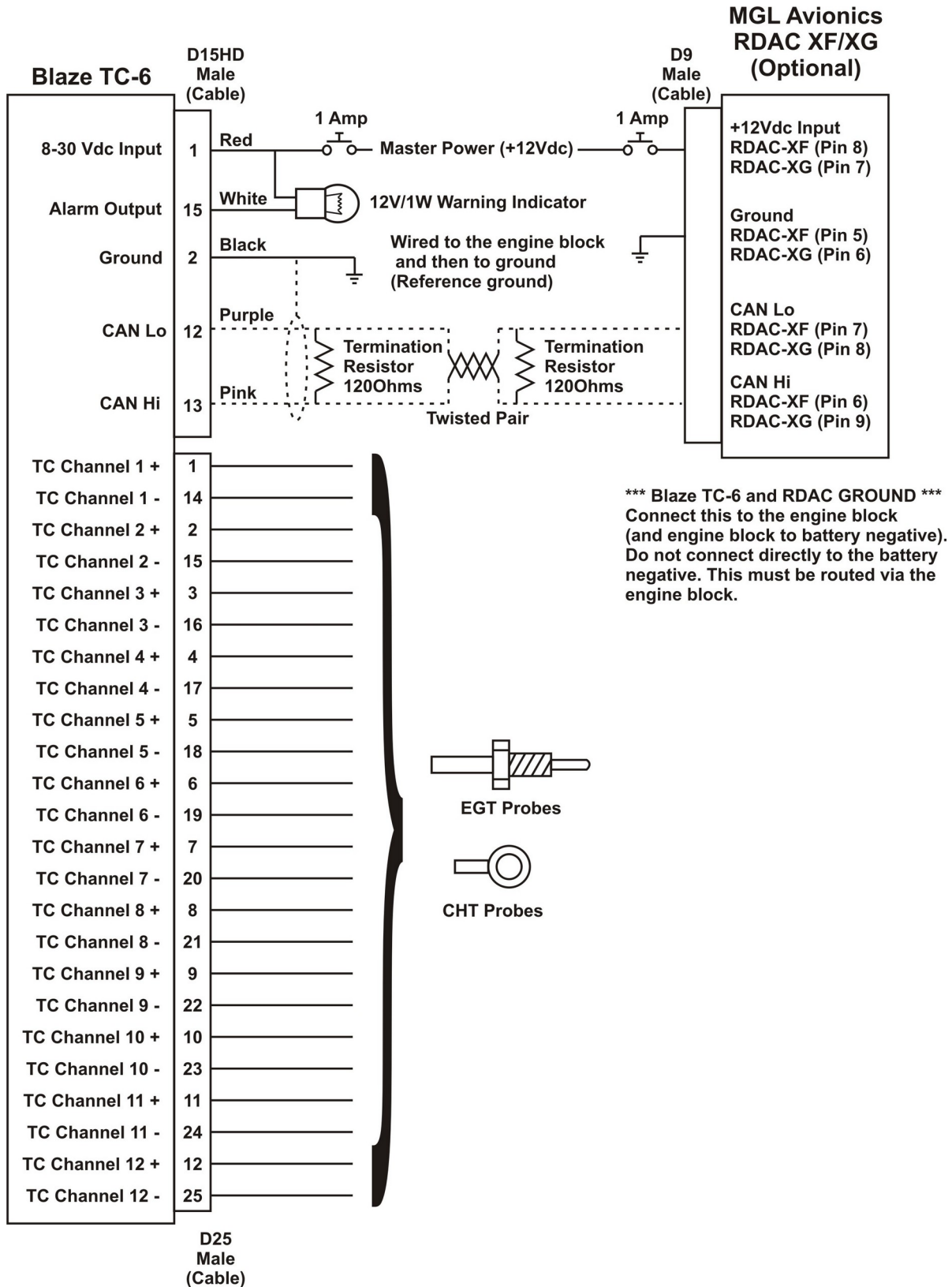

11 Dimensions

Stratomaster Blaze 3.125" (80mm) Dimensions

FRONT VIEW

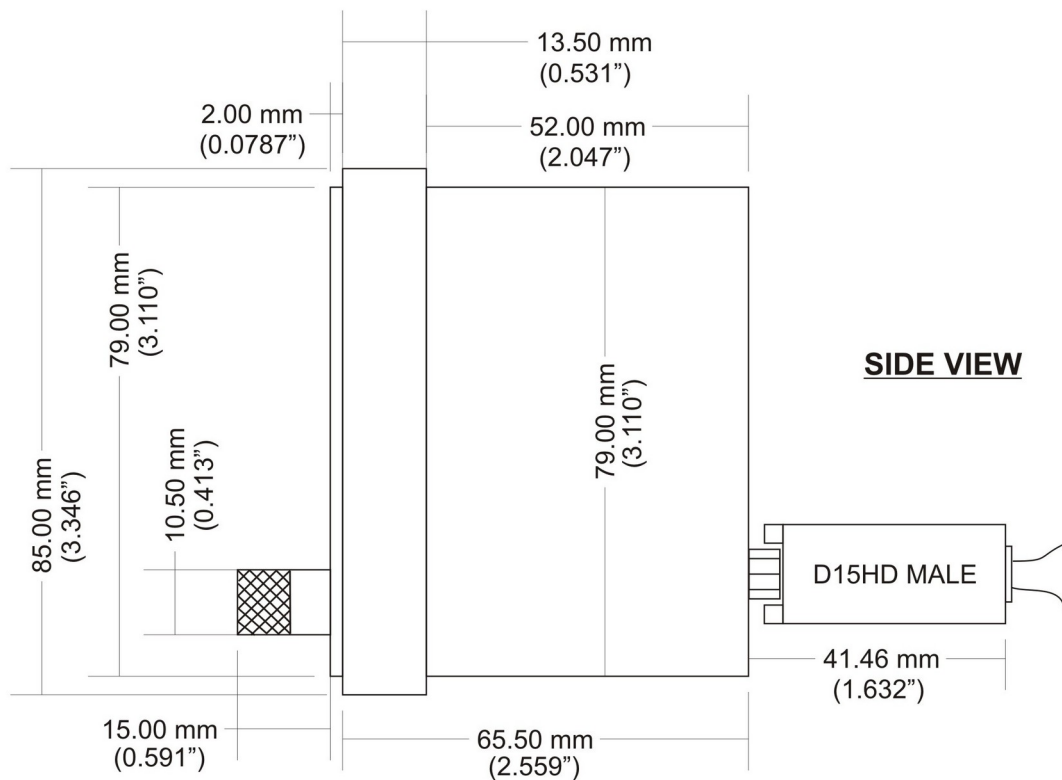
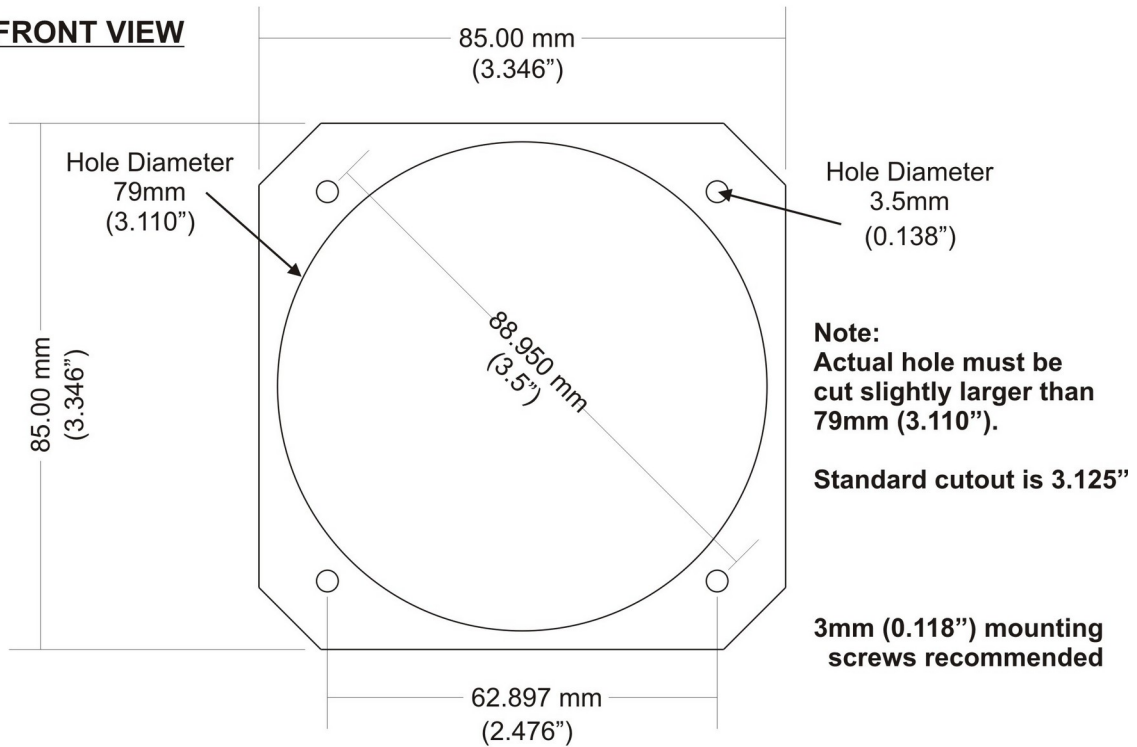

12 Cleaning

The unit should not be cleaned with any abrasive substances. The screen is very sensitive to certain cleaning materials and should only be cleaned using a clean, damp cloth.

Warning: The TC-6 is not waterproof, serious damage could occur if the unit is exposed to water and/or spray jets.

13 Warranty

This product carries a warranty for a period of one year from date of purchase against faulty workmanship or defective materials, provided there is no evidence that the unit has been mishandled or misused. Warranty is limited to the replacement of faulty components and includes the cost of labor. Shipping costs are for the account of the purchaser.

Note: Product warranty excludes damages caused by unprotected, unsuitable or incorrectly wired electrical supplies and or sensors, and damage caused by inductive loads.

14 Disclaimer

Operation of this instrument is the sole responsibility of the purchaser of the unit. The user must make themselves familiar with the operation of this instrument and the effect of any possible failure or malfunction.

This instrument is not certified by the FAA. Fitting of this instrument to certified aircraft is subject to the rules and conditions pertaining to such in your country. Please check with your local aviation authorities if in doubt. This instrument is intended for ultralight, microlight, home built and experimental aircraft. Operation of this instrument is the sole responsibility of the pilot in command (PIC) of the aircraft. This person must be proficient and carry a valid and relevant pilot's license. This person has to make themselves familiar with the operation of this instrument and the effect of any possible failure or malfunction. Under no circumstances does the manufacturer condone usage of this instrument for IFR flights.

IMPORTANT NOTICE:

You must make your own determination if the products sold by MGL Avionics are safe and effective for your intended applications. MGL Avionics makes no representations or warranties as to either the suitability of any of the products we sell as to your particular application or the compatibility of any of the products we sell with other products you may buy from us or anywhere else, and we disclaim any warranties or representations that may otherwise arise by law. Also, we offer no specific advice on how to install any of the products we sell other than passing along anything that may have been provided to us by the manufacturer or other issues. If you are in need of further information or guidance, please turn to the manufacturer, FAA Advisory Circulars and guidance materials, the Experimental Aircraft Association, or other reputable sources.

Continuing development sometimes necessitates specification changes without notice.

Other instruments in the *Stratomaster Blaze* series

AHRS-2	Artificial Horizon and Magnetic Compass Indicator
AHRS-4	Self contained Artificial Horizon and Magnetic Compass Indicator
ALT-6	Altimeter and Vertical Speed Indicator (VSI)
ALT-7	Altimeter and Vertical Speed Indicator (VSI) with a transponder compatible RS232 & parallel Gillham code output
ASI-5	Airspeed Indicator (ASI)
ASI-5HS	Airspeed Indicator (ASI High Speed)
ASV-2	Altimeter, Airspeed (ASI) and Vertical Speed Indicator (VSI)
ASV-2HS	Altimeter, Airspeed (ASI High Speed) and Vertical Speed Indicator (VSI)
EMS-2	Engine Monitoring System
FF-5	Fuel Computer
FLIGHT-3	Primary Flight Instrument
INFO-2	Information Display (G-Force meter, UTC and Local Time, Slip Indicator, Outside Air Temperature (OAT), Battery Voltage, Current and charge display, Flight Timer & Flight Log, Stopwatch, Countdown Timer and Alarm)
MAG-2	Magnetic Compass Indicator
MAP-4	Manifold Pressure and RPM Indicator
RPM-2	Universal Engine / Rotor RPM Indicator
TC-5	4 Channel Thermocouple (EGT/CHT) Indicator
TC-6	12 Channel Thermocouple (EGT/CHT) Indicator
TP-4	4 Channel Universal Analog Input (Pressure/Temperature/Current/Volts) Indicator